



ARCHITECTURAL LIGHTING + DESIGN / DECORATIVE FEATURES

SPRNG Architectural Lighting is an architectural / design lighting manufacturer focused on low-compromise lighting solutions for spec driven projects.

- Specification grade linear lighting
- Feature-rich design / decorative lighting
- 5-10 Day quick ship inventory





HORIZON - Recessed linear

HORIZON

Up to 1,300 LM/FT

2' min. 1' increments

Suspended / Surface / Wall / Recessed mount

Custom bends



Continuous illumination.

PRODUCT PAGE





Asiera Wealth Partners

Symbol	Price	% Chg	Vol	Market Cap	PE Ratio	Dividend Yield
ASIA	12.50	+0.10	100	1.2B	15.0	2.5%
ASIA	12.50	+0.10	100	1.2B	15.0	2.5%
ASIA	12.50	+0.10	100	1.2B	15.0	2.5%
ASIA	12.50	+0.10	100	1.2B	15.0	2.5%
ASIA	12.50	+0.10	100	1.2B	15.0	2.5%
ASIA	12.50	+0.10	100	1.2B	15.0	2.5%
ASIA	12.50	+0.10	100	1.2B	15.0	2.5%
ASIA	12.50	+0.10	100	1.2B	15.0	2.5%
ASIA	12.50	+0.10	100	1.2B	15.0	2.5%
ASIA	12.50	+0.10	100	1.2B	15.0	2.5%



HORIZON

ASTERA
WEALTH PARTNERS
— Global Financial Solutions

SPRNGTM
architectural lighting

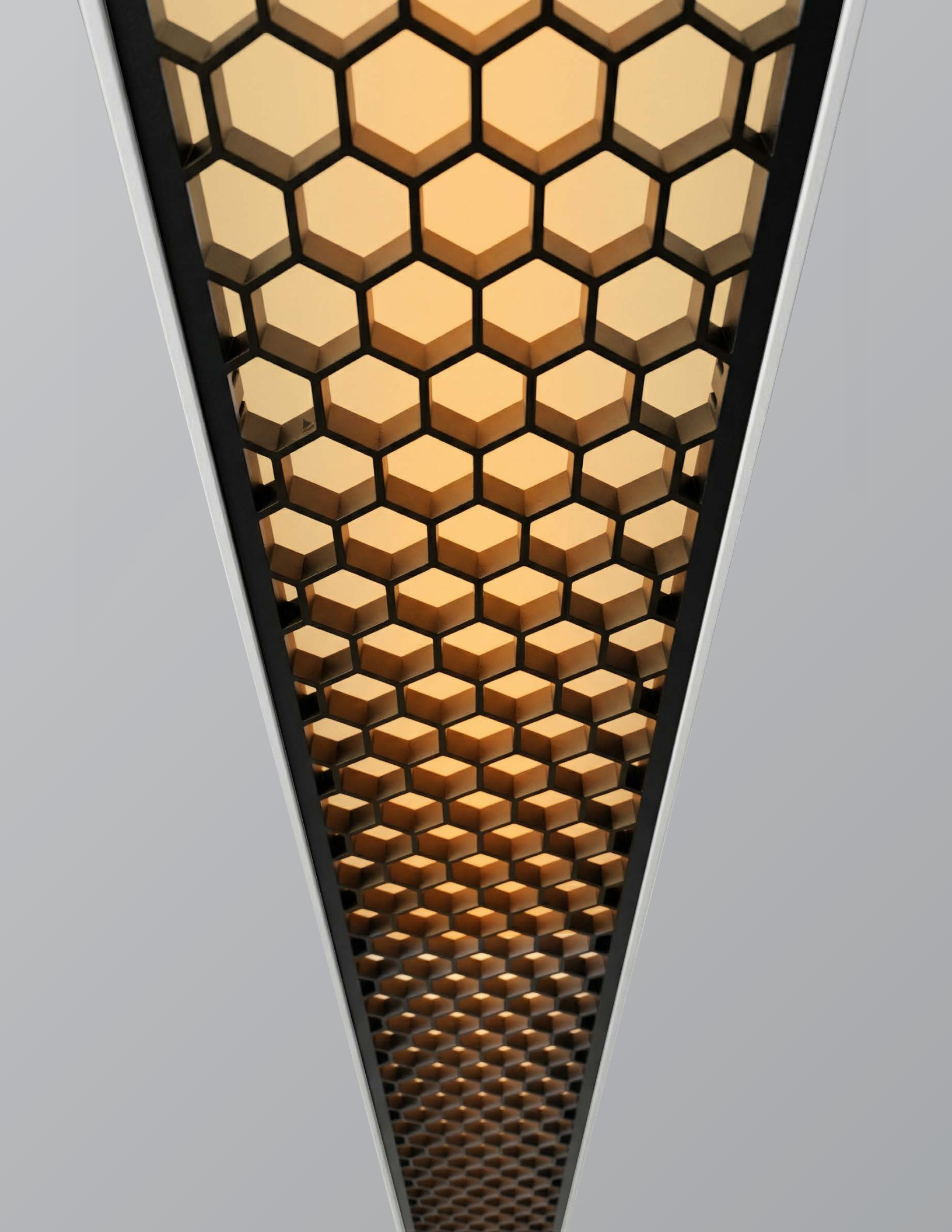



Lens:

Direct:



Direct flush frosted PC lens



Asymmetric



1/4" Glow lens

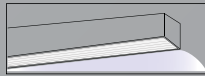

Bidirection

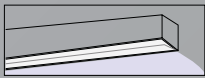

Wall Wash

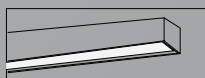

Regress

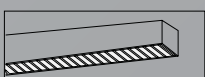

Louver

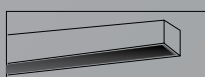

Black PC Lens

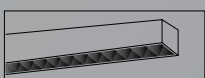

UGR Louver Reflector

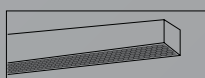

Hex Louver

Indirect:

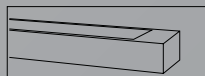

Indirect Batwing PC lens

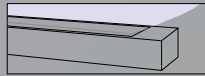

Asymmetric

Joiner:

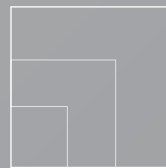

L

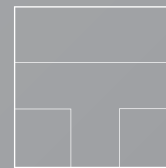

T

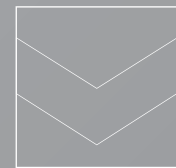

V

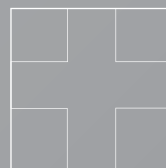

X



Y



HORIZON



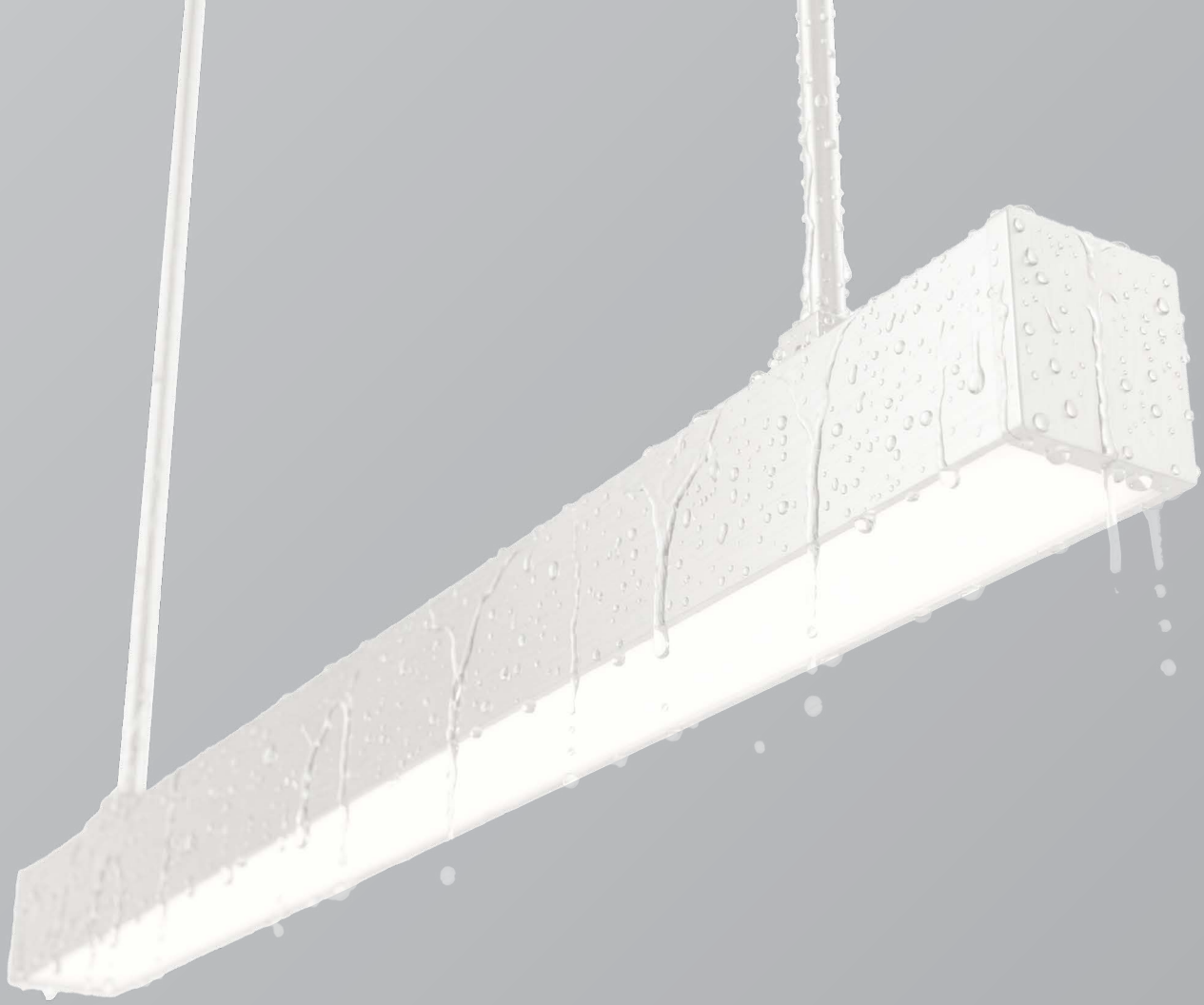

ATMOS

Wet location - IP65 rated

Up to 1,500 LM/FT

Screwless endcap, seamless form.

Continuous illumination up to 8' with
minimal break for gasketed joiners.

Suspended / Surface / Wall mount.



PRODUCT
PAGE

ATMOS





CYN

Precision light spread, controlled beam angles.
0° - 90° adjustable arm tilt with 360° turning radius
for exact directional illumination.
Dim to Warm available



Adjustable arm
surface mount



Pendant
mount



Stem
mount

featuring
ball rotator knuckle
for angled mounting

PRODUCT PAGE









CYN - Hex Louver



CYN - Cross Baffle

Trim:

Standard:

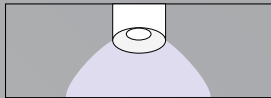

Standard Vortex Baffle

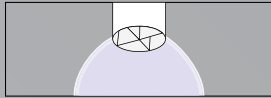

Cross Baffle

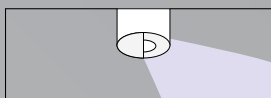

Wall Wash Baffle

Lens:

Standard

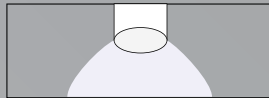

Soft Lens

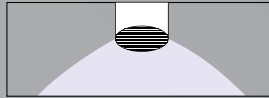

Linear Spread

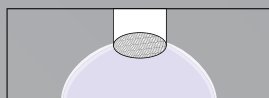

Hex Louver

Wall Wash

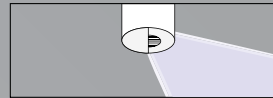

Single Side Wall Wash

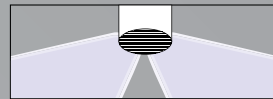

Double Sided Wall Wash

Optics:

Photometry:



18° Flood

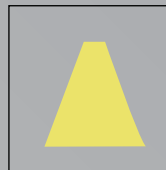

24° Flood

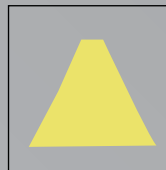

36° Flood

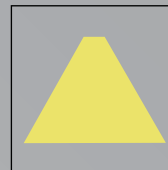

50° Flood



CYN



SPRNG™
architectural lighting

CHANNEL

<19 UGR linear

Direct - optional indirect module

Suspended / Wall mount

Up to 1,250 LM/FT

Continuous runs / 90° bends



PRODUCT
PAGE

CHANNEL

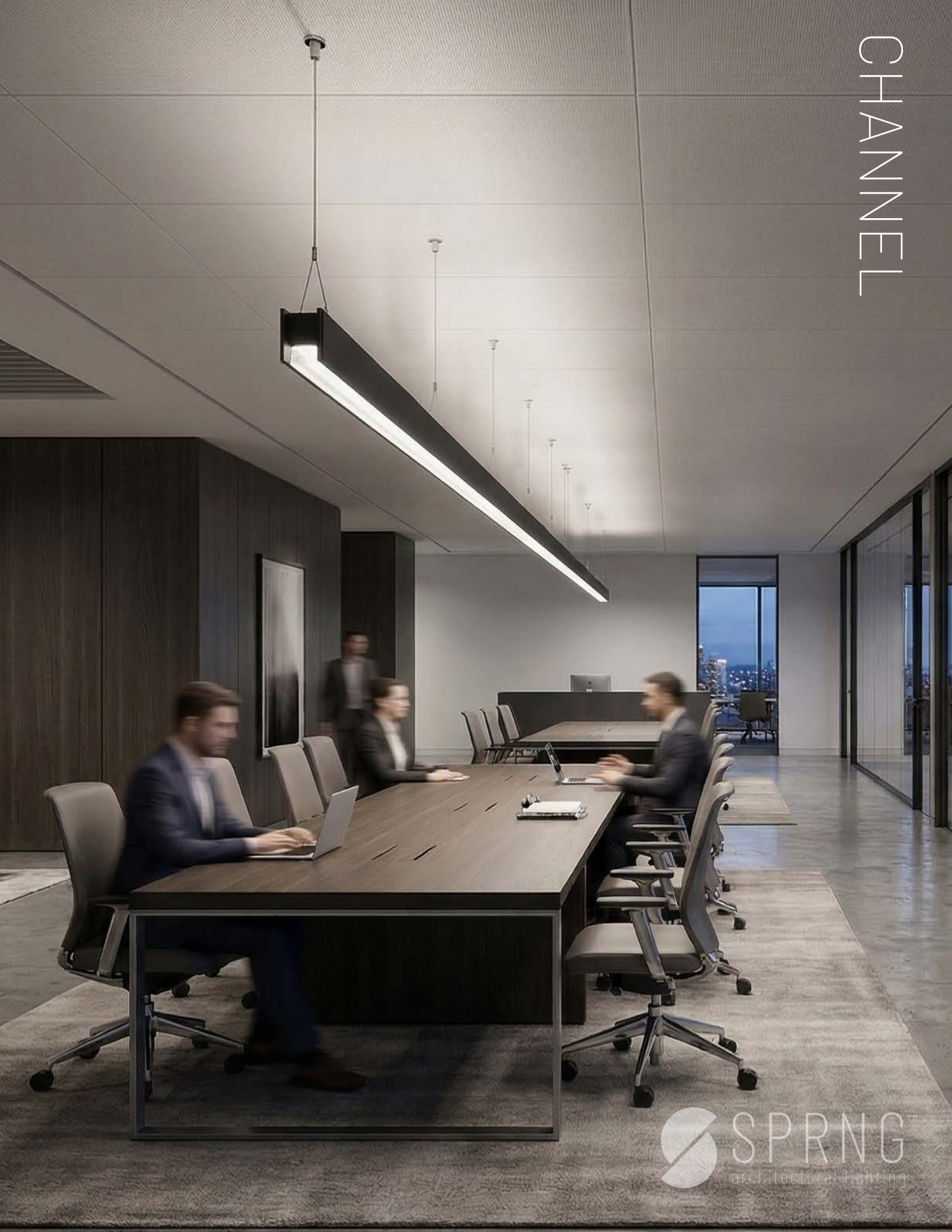

NANO



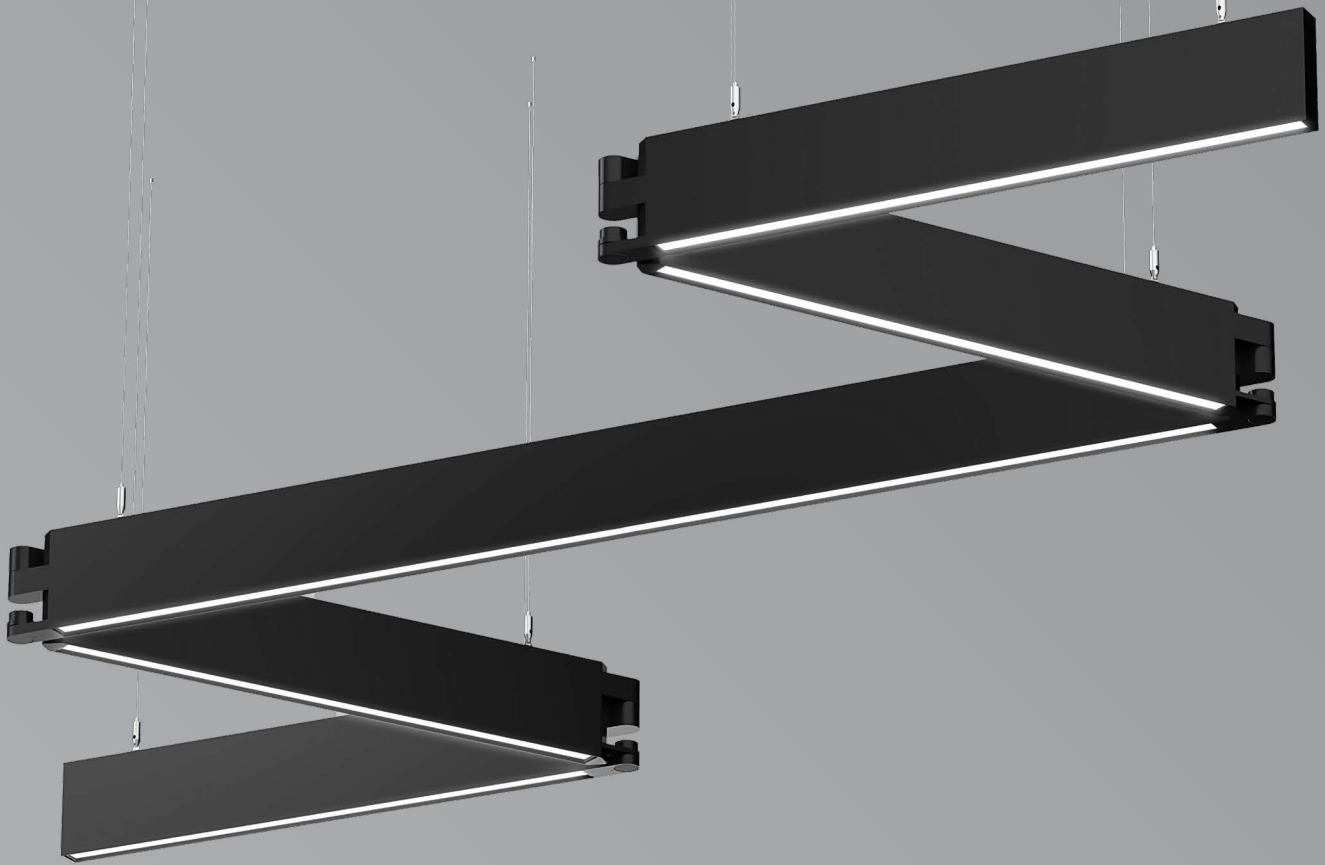

NANO

0.9" Profile

30° / 60° / 90° direct

Batwing Indirect

Suspended

Up to 1,250 LM/FT

0 - 240° joiner module



PRODUCT
PAGE

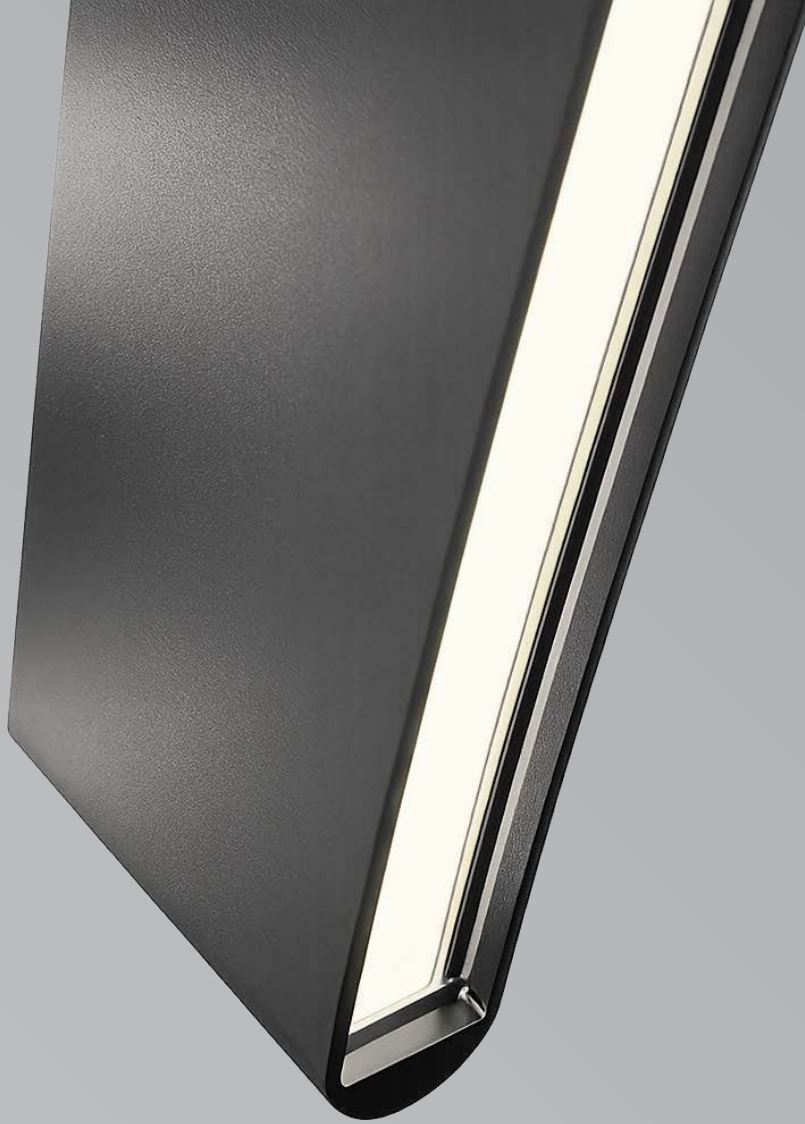

PRODUCT
PAGE

FIREFLY

0.9" Profile
Wall mount
60° Direct / Batwing indirect

FIREFLY



DRUM

2' / 3' / 4' Round

Flat opal PC lens

Optional drop lens / regress flat lens

Indirect module available



PRODUCT
PAGE



DRUM



RINGS



Azyic
BOUTIQUE

Azyic

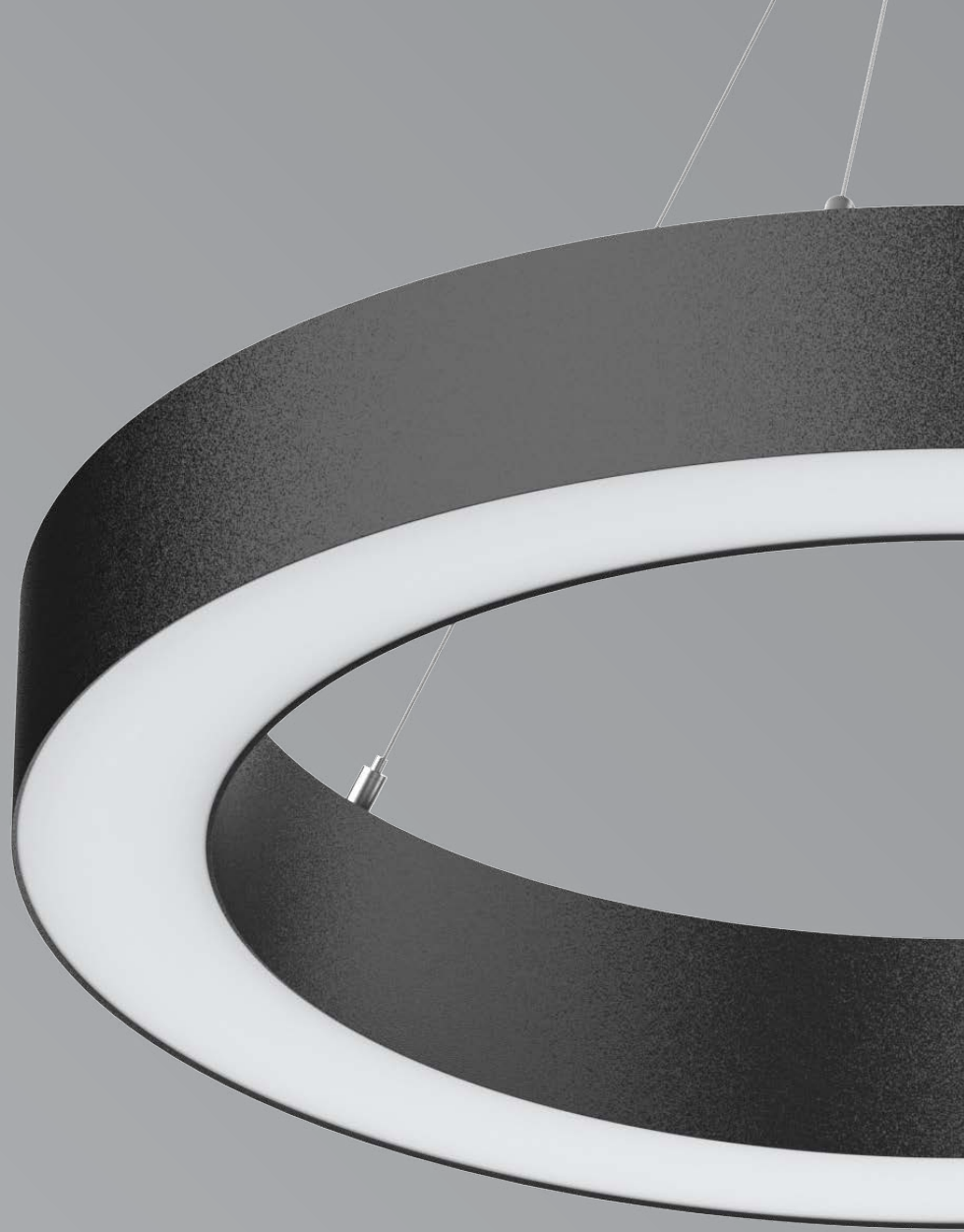

RING

2' / 3' / 4' Round

Flat opal PC lens

Indirect module available.



PRODUCT
PAGE

SERENITY





SERENITY

Open center pendant
Angled lens design for seamless direct /
indirect light spread
2' / 4' / 8'
Linkable bracket for continuous runs
and 90° bends



PRODUCT
PAGE

SPRNGArch.com exclusive

PRODUCT BUILDER

Real time project / product builder.
Create a BOM in seconds.
Faster PM, faster POs.

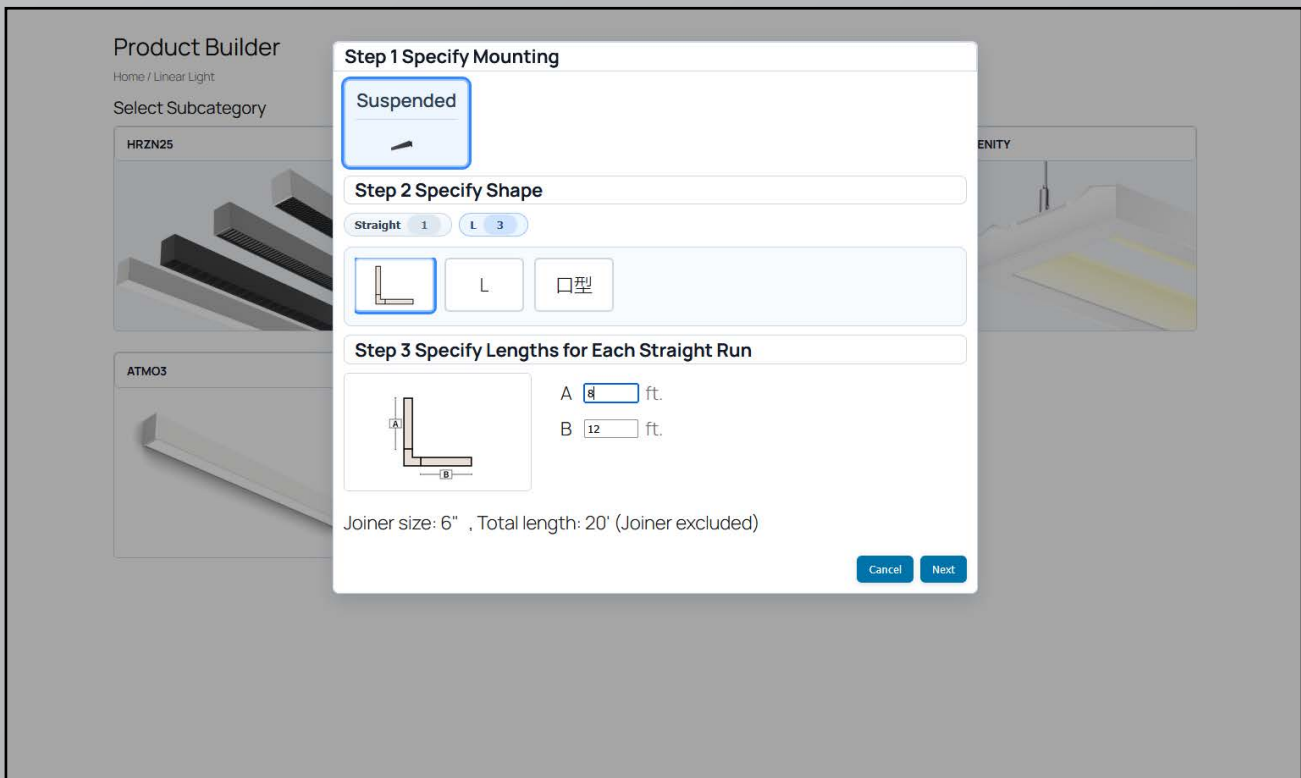

The screenshot displays the 'Product Builder' software interface. On the left, there is a sidebar with 'Product Builder' at the top, followed by 'Home / Linear Light' and 'Select Subcategory'. Below this, two subcategories are visible: 'HRZN25' and 'ATM03'. The main area shows a 3D rendering of a linear light fixture. A dialog box titled 'Step 1 Specify Mounting' is open, showing 'Suspended' as the selected option. Below this is 'Step 2 Specify Shape', with 'Straight' selected (count 1) and 'L' selected (count 3). There are also icons for 'L' and a Korean character 'ㄷ'. 'Step 3 Specify Lengths for Each Straight Run' shows a diagram of an L-shaped run with dimensions A and B. Input fields show A as 8 ft. and B as 12 ft. Below the diagram, it states 'Joiner size: 6" , Total length: 20' (Joiner excluded)'. At the bottom right of the dialog are 'Cancel' and 'Next' buttons.

BUILD A BOM IN SECONDS

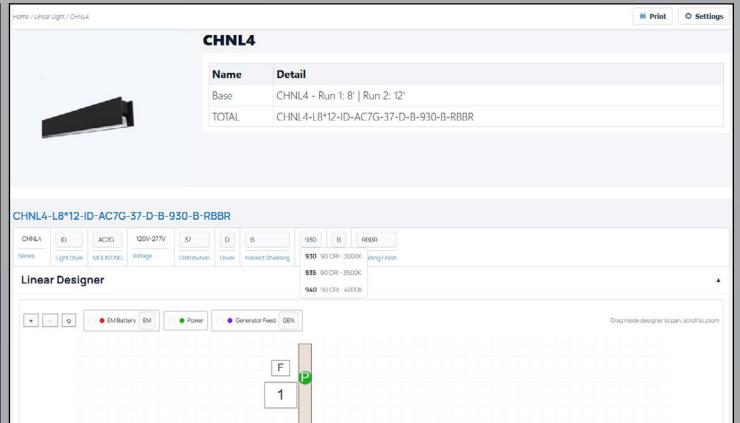
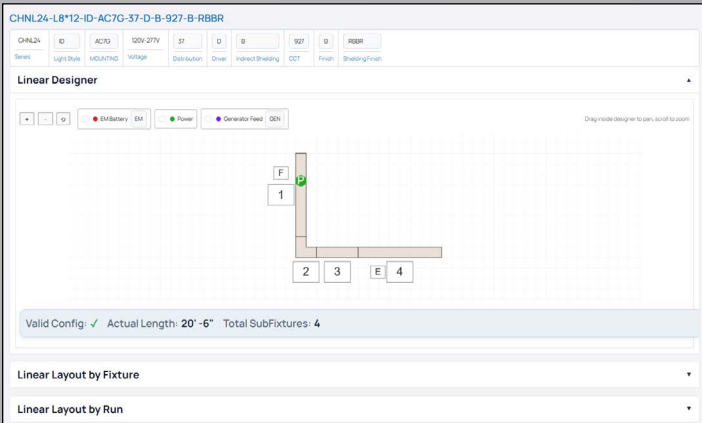

Add to, update, or reconfigure specs in real time.

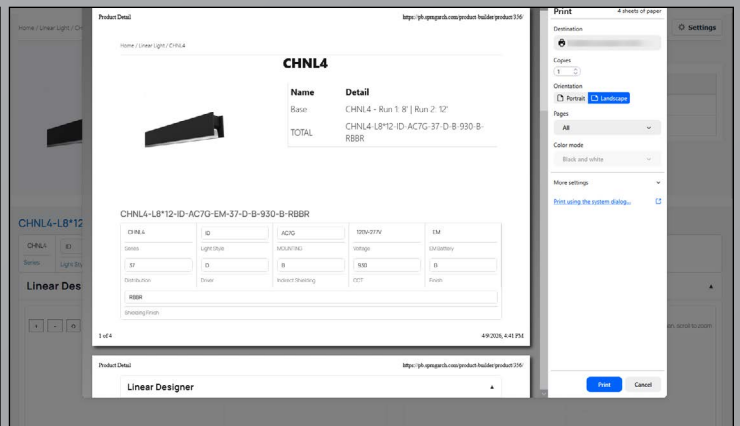
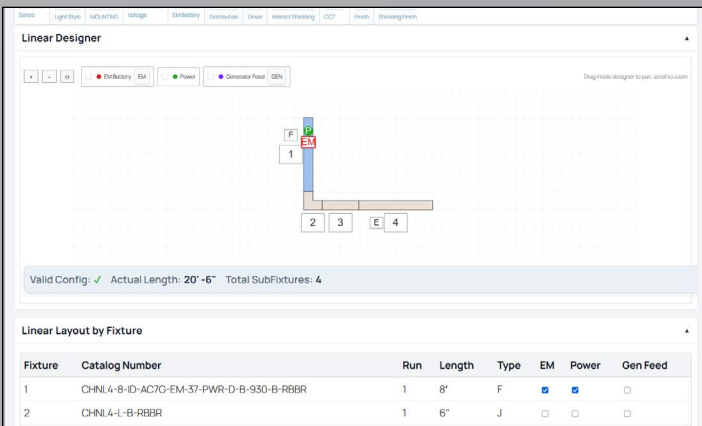

Confirm Power Feeds, Sensors, Emergency Backups, Fixture Lengths and more.

Generate a data sheet instantly.

SPRNGArch.com



11325 CASH RD, SUITE 100, STAFFORD, TX, 77477

WWW.SPRNGARCH.COM